

PATENT PENDING



RoofGooseVent LLC,
345 Compass Cir #17
North Kingstown, RI 02852
Telephone: 401-522-9857
www.RoofGooseVent.com
sales@RoofGooseVent.com

Model

RJ6 - Utility

Application

- 6" Flat Roof utility termination. Designed to accommodate any flexible/malleable materials that are typically flashed to the roof using a pitch pocket.

Item Description

1. Roof Sub Structure
2. Insulation And Roof Membrane
3. Roofer's Flashing (Field Supplied)
4. Roofgoosejack Base With Flange
5. Roofgoosejack Lid
6. Removable Flexible Line Set Jacket
7. Included Draft Stopping
8. (A&B) Stainless Steel Hose Clamp
9. 8 Inch Roof Fasteners
10. Gasket Under Flange
11. Hole Through The Roof

Updated 03-27-23

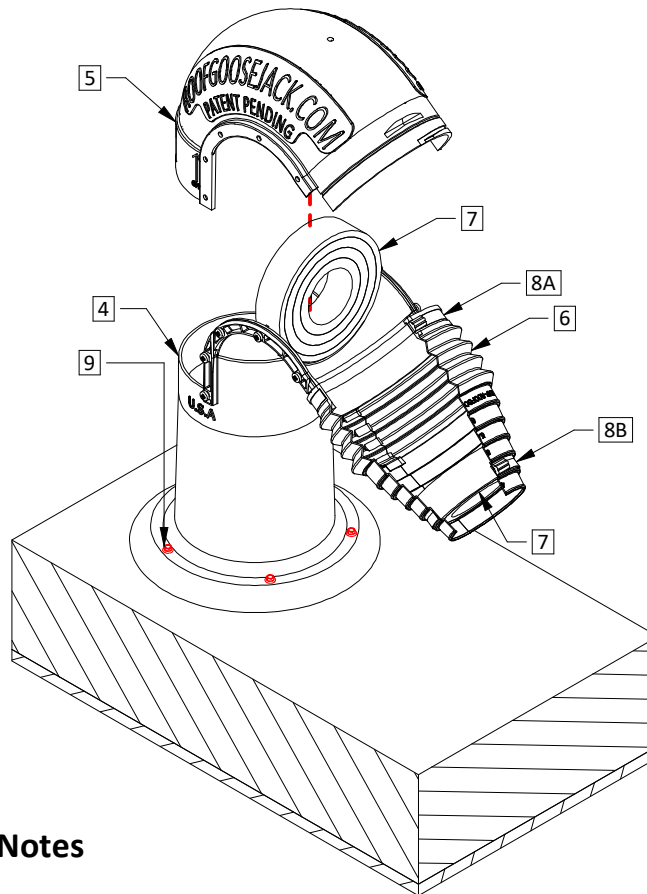

Installation Notes

1. **Draft Stopping Location (item #7 QTY 2)** - The first one is to be installed at the high point of the neck where keyways are located. The Second draft stopping is to be installed at one step back from your desired outlet diameter.
2. **Draft Stopping Fitment (item #7 QTY2)** - make sure that foam rings have a snug fit around your lines coming out of the device. The hose clamps and shell back will help compress the draft stopping and fill the irregular shape of your grouping of pipes.
3. **Hose Clamp and flexible jacket Location & Fitment (item #8 QTY2)** - Trim the flexible jacket (Item#6 QTY1) using tin snips or scissors. Once the jacket is trimmed to desired outlet diameter wrap the jacket around the outlet of the gooseneck and close the seam of the jacket using the pull through locks (Be gentle they are rubber).Then install the first hose clamp in the groove around the jacket at the outlet of the device (Item 8A). The second hose Clamp should be installed one notch back from the outlet of the flexible jacket bearing down on the draft stopping (item #8B).
4. **Hole Through Roof Diameter (Field Supplied Hole Saw Recommended)** - When preparing a hole for the RJ6-Utility (item #11) we find it best to use a 6.5" Hole saw; but the termination can accommodate any size hole up to 6.5" diameter
5. **Roof Flashing Install (Field Supplied Item)** - Gasket in the base is only for temporary water protection, it is not intended to be a permanent roof flashing and requires a clean surface for the gasket to make a strong bond. Professional roof flashing (item #3) is always required after installation.
6. **Termination location** - Its recommended that the termination be mounted so that the outlet of the jacket is at least 24" away from your equipment. This is recommended so you are able to transition out of the termination and connect to your equipment.

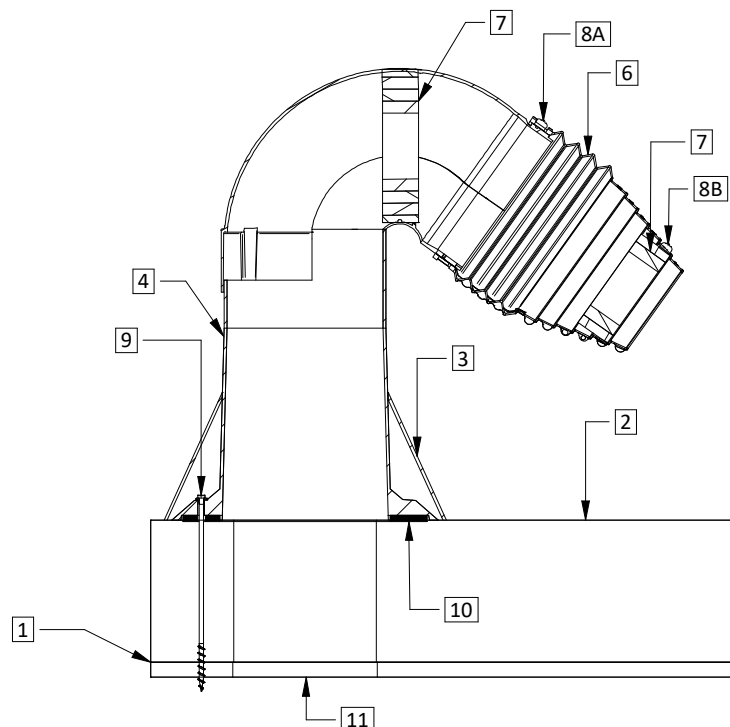

DRAFT STOPPING
LOCATION #1



ITEM 8B TO BE
INSTALLED ONE
NOTCH BACK FROM
THE OUTLET OF THE
FLEXIBLE JACKET
BEARING DOWN ON
THE DRAFT STOPPING



DRAFT STOPPING
LOCATION #2

